

Time Control Technique

MINITIMER
Timer, On delayed
IK 9906, SK 9906



- According to IEC/EN 61 812-1
- 8 time ranges from 0.05 s to 300 h selectable via rotational switches
- Voltage range AC/DC 12 ... 240 V
- Adjustment aid for quick setting of long time values
- Suitable for 2-wire proximity sensor control
- 1 changeover contact
- As option connection of a remote potentiometer 10 kΩ
- As option with time interruption / time adding input
- LED indicators for operation, contact position and time delay
- Devices available in 2 enclosure versions:
 - IK 9906: depth 59 mm, with terminals at the bottom for installation systems and industrial distribution systems according to DIN 43 880
 - SK 9906: depth 98 mm, with terminals at the top for cabinets with mounting plate and cable duct.
- 17.5 mm width

Function Diagram

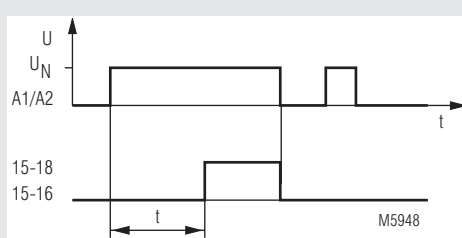

Approvals and Markings



Application

Time-dependent controllers

Indicators

- | | |
|---------------------------------|--|
| green LED: | on when voltage connected |
| yellow LED "R/t": | shows status fo output relay and time delay: |
| - Flashing (short on, long off) | output relay not active; time delay |
| - Continuously on: | output relay active; no time delay |

Circuit Diagrams

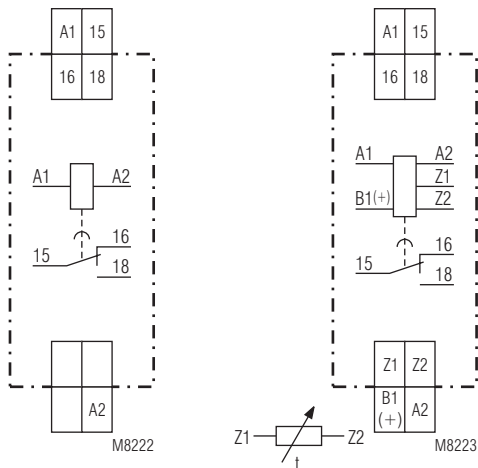

IK 9906.81
 SK 9906.81

IK 9906.81/500
 SK 9906.81/500

Connection Terminals

Terminal designation	Signal designation
A1	L / +
A2	N / -
15, 16, 18	Changeover contact
B1(+)	Control input (interruption of timing with time addition) Control with reference to A2
Z1, Z2	Input to connect a remote potentiometer for time setting

Notes

Control of A1-A2 with proximity sensors

The input can be controlled by DC 3 wire or AC/DC 2 wire proximity sensors. For operating voltage > 24 V and usage of sensors without built-in short circuit protection a protection resistor on A1 is recommended to reduce the inrush current. The dimension is as follows:

$R_v \approx$ operating voltage / max. switching current of sensor

The series resistor must not be selected higher than necessary.

Max. values are:

Operating voltage: 48 V 60 V 110 V 230 V
Series resistor R_v max: 270 Ω 390 Ω 680 Ω 1.8 k Ω (1 W)

Setting

A change of the settings for time range and time will be valid immediately. Please note, that a change of time range or time setting during elapse of time can lead to unintended switching of the output contacts.

Adjustment assistance

The flashing period of the yellow LED is $1 \text{ s} \pm 4\%$ and can be used to adjust the time. Especially on the lower end of scale and for long times it is suitable as the multiplication factors between the different time ranges are exact without tolerance.

Example:

The required time is 40 min. It has to be adjusted within the range 3 ... 300 min. The time check takes too long as several timing cycles would be necessary for a precise value.

For faster adjustment the setting is made to 0.03 ... 3 min. On this range the potentiometer should be set to 0.4 min (= 24 sec). With the right potentiometer setting the LED must show 24 flashing cycles. After that the time range is switched over to 3 ... 300 min and the setting is complete.

Time interruption / Time adding

With the model IK/SK 9906.81/500 the timing cycle can be interrupted by controlling input B1 (+) with control voltage. Removing the control signal will continue the timing cycle (time addition). When time is interrupted the yellow LED goes off.

Control input B1

The control input B1 (+) has to be supplied with voltage against A2. The control signal could be the same as the auxiliary/control voltage of A1 or any other voltage between 12 and 240 V AC or DC. Operating a parallel load between B1 and A2 is also possible.

Remote potentiometer

With the variant IK/SK 9906.81/500 the time setting can also be made via remote potentiometer of 10 kOhms. It is connected to the terminals Z1-Z2. The corresponding potentiometer on the relay has to be set to min. If no remote potentiometer is required the terminals Z1-Z2 have to be linked. The wires to the remote potentiometers should be installed separately from the lines with mains voltage. If this is not possible, a screened cable is recommended where the shield is connected to Z1.

To terminals Z1 and Z2 no external voltage must be connected, as the unit might be damaged.

Terminals Z1-Z2 do not have a galvanic separation to terminals A1/A2!

Setting

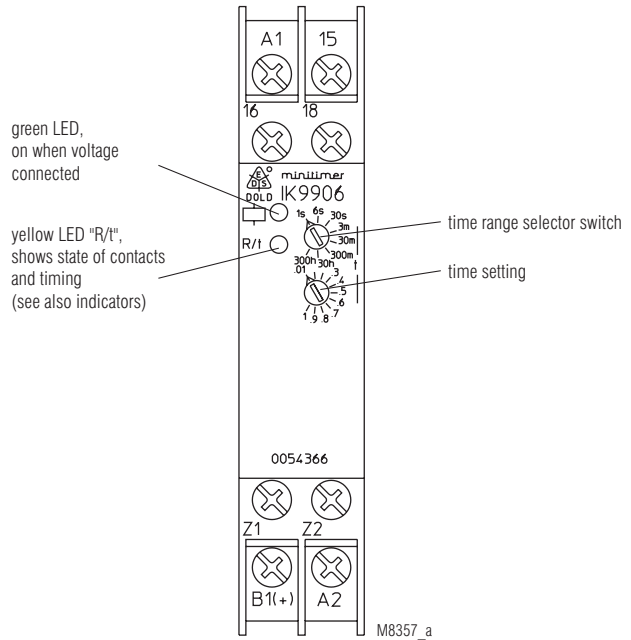

Technical Data

Time circuit

Time ranges:	8 time ranges settable via rotational switch: 0.05 ... 1 s 0.3 ... 30 min 0.06 ... 6 s 3 ... 300 min 0.3 ... 30 s 0.3 ... 30 h 0.03 ... 3 min 3 ... 300 h continuous, 1:100 on relative scale
---------------------	--

Time setting t:

Recovery time:

at DC 24 V: approx. 15 ms

at DC 240 V: approx. 50 ms

at AC 230 V: approx. 80 ms

Repeat accuracy:

± 0.5 % of selected end of scale value + 20 ms

Voltage and

temperature influence:

≤ 1 % with the complete operating range

Input

Nominal voltage U_N : AC/DC 12 ... 240 V

Voltage range: 0.8 ... 1.1 U_N

Frequency range (AC): 45 ... 400 Hz

Nominal consumption

at AC 12 V: approx. 1.5 VA

at AC 24 V: approx. 2 VA

at AC 240 V: approx. 3 VA

at DC 12 V: approx. 1 W

at DC 24 V: approx. 1 W

at DC 240 V: approx. 1 W

Release voltage (A1/A2)

AC 50 Hz: approx. 7.5 V

DC: approx. 7 V

Max. permitted residual current with 2-wire proximity sensor control (A1-A2)

up to AC/DC 150 V: AC resp. DC 5 mA

up to AC/DC 264 V: AC resp. DC 3 mA

Control voltage (B1/A2)

IK/SK 9906.81/500: AC/DC 12 ... 240 V

Voltage range (B1/A2): 0.8 ... 1.1 UN

Control current (B1)

IK/SK 9906.81/500: input resistance approx. 220 kΩ in series with diode

Release voltage (B1/A2)

IK/SK 9906.81/500:

AC 50 Hz: approx. 5 V

DC: approx. 4 V

Output

Contacts

IK/SK 9906.81: 1 changeover contact

Contact material: AgNi

Measured nominal voltage: AC 250 V

Thermal current I_{th} : 4 A
(see see quadratic total current limit curve)

Switching capacity

to AC 15

NO contact: 3 A / AC 230 V IEC/EN 60 947-5-1

NC contact: 1 A / AC 230 V IEC/EN 60 947-5-1

to DC 13: 1 A / DC 24 V

Electrical life

to AC 15 at 1 A, AC 230 V: 1.5 x 10⁶ switch.cycles IEC/EN 60 947-5-1

Permissible switching

frequency: 36 000 switching cycles / h

Short circuit strength

max. fuse rating: 4 A gL IEC/EN 60 947-5-1

Mechanical life: ≥ 30 x 10⁶ switching cycles

Technical Data

General Data

Operating mode: Continuous operation

Temperature range:

Operation: - 40 ... + 60 °C
(higher temperature with limitations see quadratic total current limit curve)

Storage: - 40 ... + 70 °C

Relative air humidity: 93 % at 40 °C

Altitude: < 2.000 m

Clearance and creepage distances

rated impulse voltage /

pollution degree:

4 kV / 2 (basis insulation) IEC 60 664-1

Overvoltage category:

Insulation test voltage, type test: 2.5 kV; 1 min

EMC

Electrostatic discharge: 8 kV (air) IEC/EN 61 000-4-2

HF irradiation

80 MHz ... 1 GHz: 20 V / m IEC/EN 61 000-4-3

1 GHz ... 2.7 GHz: 10 V / m IEC/EN 61 000-4-3

Fast transients:

A1/A2 and B1(+)/A2 4 kV IEC/EN 61 000-4-4

Z1/Z2: 2 kV IEC/EN 61 000-4-4

Surge voltages

between

wires for power supply: 2 kV IEC/EN 61 000-4-5

between wire and ground: 4 kV IEC/EN 61 000-4-5

HF-wire guided: 10 V IEC/EN 61 000-4-6

Interference suppression: Limit value class B EN 55011

Degree of protection

Housing: IP 40 IEC/EN 60 529

Terminals: IP 20 IEC/EN 60 529

Housing:

Thermoplastic with V0 behaviour according to UL subject 94

Vibration resistance: Amplitude 0.35 mm, frequency 10 ... 55 Hz, IEC/EN 60 068-2-6 40 / 060 / 04 IEC/EN 60 068-1

Climate resistance:

Terminal designation: EN 50 005

Wire connection: DIN 46 228-1/-2/-3/-4

Cross section: 2 x 2.5 mm² solid or

2 x 1.5 mm² stranded wire with sleeve

Stripping length: 10 mm

Wire fixing:

Flat terminals with self-lifting clamping piece IEC/EN 60 999-1

0.8 Nm

Mounting: DIN rail IEC/EN 60 715

Weight:

IK 9906: approx. 65 g

SK 9906: approx. 84 g

Dimensions

Width x height x depth:

IK 9906: 17.5 x 90 x 59 mm

SK 9906: 17.5 x 90 x 98 mm

Standard Type

IK 9906.81 AC/DC 12 ... 240 V 0.05 s ... 300 h

Article number: 0054364

• Output: 1 changeover contact

• Nominal voltage U_N : AC/DC 12 ... 240 V

• Time ranges: 0.05 s ... 300 h

• Width: 17.5 mm

SK 9906.81 AC/DC 12 ... 240 V 0.05 s ... 300 h

Article number: 0054364

• Output: 1 changeover contact

• Nominal voltage U_N : AC/DC 12 ... 240 V

• Time ranges: 0.05 s ... 300 h

• Width: 17.5 mm

Variant

IK/SK 9906.81/500:

- Connection facility for a remote potentiometer 10 kOhms to adjust the time
- Additional control input B1 for time interruption / time addition

Ordering example for variant

IK 9906 .81 / _ _ AC/DC 12 ... 240 V 0.05 s ... 300 h

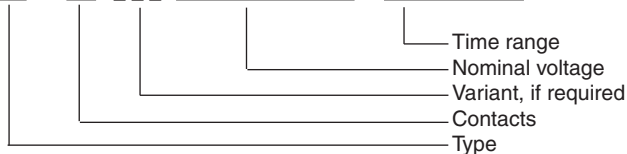

Characteristics

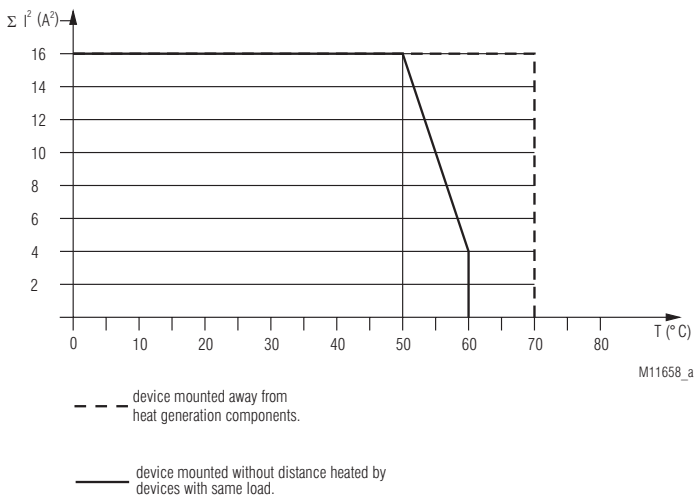

Connection Diagrams

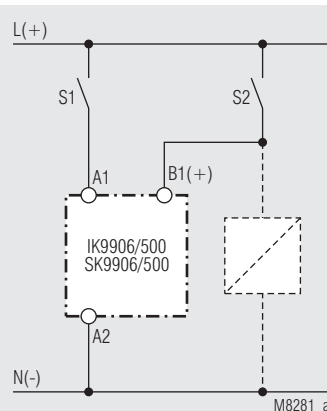
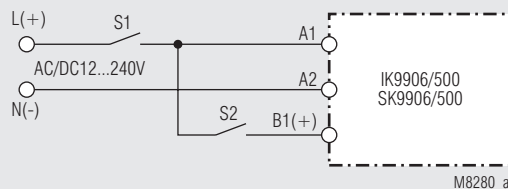

Control with parallel connected load

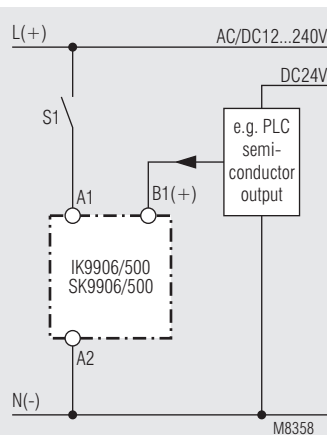

Connection with 2 different control voltages

Accessories

AD 3:

External potentiometer 10 kΩ
 Article number: 0028962

The external potentiometer is used for remote setting of the time delay. The internal potentiometer of the timer must be set to min. time delay.

Degree of protection front side:

IP 60

